

RFMD 

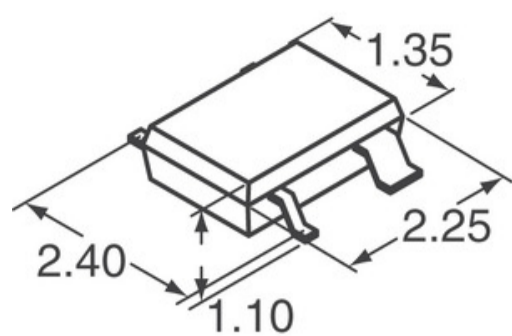

Afbeelding kan representatie zijn.
Zie specificaties voor productdetails.

SGA-8343Z

Onderdeel nummer: **SGA-8343Z**
 product beschrijving: IC RF AMP PCS 0HZ-6GHZ SOT343
 RoHS-status: Loodvrij / RoHS-conform
 Datasheets: [SGA-8343Z.pdf](#)











Fabrikant / Merk: RFMD
 Verscheppen van: Hong Kong
 Zending manier: DHL/Fedex/TNT/UPS/EMS

 **AANVRAAG INDIENEN** >

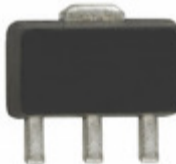
Productdetails

Onderdeel nummer	SGA-8343Z	Fabrikant	RFMD
Beschrijving	IC RF AMP PCS 0HZ-6GHZ SOT343	Leid Free Status / RoHS Status	Loodvrij / RoHS-conform
Data papier	SGA-8343Z.pdf		
Voltage - Levering	4V	Test Frequency	1.95GHz
Leverancier Device Pakket	SOT-343	Serie	-
RF-Type	PCS, RFID, 3G	Packaging	Tape & Reel (TR)
Verpakking / doos	SC-82A, SOT-343	P1dB	7.5dBm ~ 9dBm
Andere namen	599-1055-2 SGA8343Z	ruisgetal	1.4dB ~ 1.75dB
Vochtgevoeligheidsniveau (MSL)	1 (Unlimited)	Loodvrije status / RoHS-status	Lead free / RoHS Compliant
Krijgen	17.5dB	Frequentie	0Hz ~ 6GHz
gedetailleerde beschrijving	RF Amplifier IC PCS, RFID, 3G 0Hz ~ 6GHz SOT-343	Current - Supply	50mA

gerelateerde producten

 <p>SGA-6586Z fabrikanten: RFMD Beschrijving: IC AMP HBT SIGE 4000MHZ SOT-86 RFQ</p>	 <p>SGA-9289 fabrikanten: RFMD Beschrijving: IC RF AMP WLL 0HZ-3GHZ SOT89-3 Download: SGA-9289.pdf RFQ</p>
 <p>SGA-9289Z fabrikanten: RFMD Beschrijving: IC AMP HBT SIGE 3GHZ SOT-89 Download: SGA-9289Z.pdf RFQ</p>	 <p>SGA-7489 fabrikanten: RFMD Beschrijving: IC RF AMP GP 0HZ-3GHZ SOT89-3 Download: SGA-7489.pdf RFQ</p>
 <p>SGA-9189 fabrikanten: RFMD Beschrijving: IC RF AMP WLL 0HZ-3GHZ SOT89-3 RFQ</p>	 <p>SGA-9189Z fabrikanten: RFMD Beschrijving: IC AMP HBT SIGE 3GHZ SOT-89 RFQ</p>
 <p>SGA-8343 fabrikanten: RFMD Beschrijving: IC RF AMP PCS 0HZ-6GHZ SOT343 Download: SGA-8343.pdf RFQ</p>	 <p>SGA-6589 fabrikanten: RFMD Beschrijving: IC AMP CELLULAR 0HZ-3.5GHZ SOT89 Download: SGA-6589.pdf RFQ</p>
 <p>SGA-7489Z fabrikanten: RFMD Beschrijving: IC AMP HBT SIGE 3000MHZ SOT-89 RFQ</p>	 <p>SGA12E05-USB fabrikanten: MEAN WELL Beschrijving: AC/DC WALL MOUNT ADAPTER 5V 12W RFQ</p>
 <p>SGA-6589Z fabrikanten: RFMD Beschrijving: IC AMP HBT SIGE 3500MHZ SOT-89 RFQ</p>	 <p>SGA12E05-P1J fabrikanten: MEAN WELL Beschrijving: AC/DC WALL MOUNT ADAPTER 5V 12W RFQ</p>

Gerelateerde tags

RFMD SGA-8343Z
 SGA-8343Z prijs
 SGA-8343Z PDF-gegevensblad
 SGA-8343Z voorraad
 RFMD SGA-8343Z
 RFMD SGA-8343Z

SGA-8343Z-distributeur
 SGA-8343Z Afbeeldingen
 SGA-8343Z Datasheet downloaden
 Koop SGA-8343Z
 RFMD Leverancier

SGA-8343Z leverancier
 SGA-8343Z-afbeelding
 SGA-8343Z gegevensblad
 Koop RFMD SGA-8343Z
 RFMD-distributeur