

MINI-DC-UPS/24DC/2

Uninterruptible power supply

INTERFACE

Data Sheet

103123_00_en

© PHOENIX CONTACT - 01/2007



Description

Especially compact and easy-to-use, the new MINI-DC-UPS/24 DC/2 is a combination of the power supply unit and an uninterruptible power supply in the conventional ME housing. It secures the operation of all connected 24 V consumers in the electrical systems both in the case of an error-free supply network and in the event of mains interferences.

The combined solution enables a slim design with dimensions of 67.5 x 99 x 107 mm. The wide-range input allows input voltages between 85 V AC and 264 V AC; 2 A is provided at the output with a regulated and adjustable output voltage between 22.5 V DC and 29.5 V DC. The rechargeable battery module supplies an output voltage between 27.9 V DC and 19.2 V DC in the buffer mode. A 0.8 Ah or a 1.3 Ah rechargeable battery module is used depending on the required buffer time: The module thus supplies 2 A for five minutes with the 0.8 Ah rechargeable battery module or 2 A for 30 minutes with the 1.3 Ah rechargeable battery module. The buffer time varies depending on the load current.

The system availability is increased using extensive signaling through control lamps and active switching outputs. The charging process of the rechargeable battery module, the operational readiness, the buffer mode and the alarm messages are displayed before the rechargeable battery module is discharged. The service life of the rechargeable battery module can be increased by optimum battery management; for example, a temperature-compensated charging protects the rechargeable battery module at high ambient temperatures. An integrated timeout minimizes installation costs considerably.



Danger!

**Components with dangerously high voltage and high stored energy are located in the device!
Never carry out work on live parts!
Depending on the ambient temperature and the load, the housing can become very hot!**



Make sure you always use the the latest documentation.
It can be downloaded at www.download.phoenixcontact.com.
A conversion table is available on the Internet at
www.download.phoenixcontact.com/general/7000_en_00.pdf.

Order data

Description	Type	Order No.	Pcs./Pkt.
Uninterruptible power supply	MINI-DC-UPS/24DC/2	2866640	1
Accessories	Type	Order No.	Pcs./Pkt.
Battery module, 24 V DC, 0.8 Ah	MINI-BAT/24DC/0.8AH	2866666	1
Battery module, 24 V DC, 1.3 Ah	MINI-BAT/24DC/1.3AH	2866417	1

Technical data

Input data	
Input nominal voltage range	100 V AC ... 240 V AC
AC input voltage range	85 V AC ... 264 V AC
DC input voltage range	100 V DC ... 350 V DC
Buffer period	(settable: 0.5 min; 1 min; 2 min; 3 min; 5 min; 10 min; 15 min; 20 min; 30 min; continuous)
Current consumption	Approx. 0.6 A (230 V AC)
	Approx. 1.1 A (115 V AC)
Inrush current limitation/ I^2t	< 34 A (< 1.1 A ² s)
Power failure bypass	(refer to the diagram)
Typical response time	100 ms
Power factor (cos phi)	Approx. 0.5
Protective circuitry	Varistor
Input fuse, integrated	3.15 A (slow-blow, internal)
Output data	
Nominal output voltage	24 V DC
Setting range of the output voltage	22.5 V DC ... 29.5 V DC (normal mode; in the buffer mode, dependent on a battery voltage of 27.9 V DC ... 19.2 V DC)
Output current	2 A
Derating	From +60°C 2.5% per Kelvin
Output current limit	Max. 3 A
Max. capacitive load	Unlimited
Control deviation	< 1 % (change in load, static 10% ... 90%)
Power loss	Max 2,5 W (buffer mode)
Power loss nominal load max.	15 W
Maximum power dissipation idling	3.8 W
Efficiency	> 82 % (typical)
Ascent time	< 100 ms
Residual ripple	< 50 mV _{PP}
Peak switching voltages	< 100 mV _{PP}
Connection in parallel	Yes, for redundancy
Surge protection against internal surge voltages	Yes, < 35 V DC
Resistance to reverse feed	35 V DC
Signal output Power OK	
Status display	Green LED (Power OK: LED permanently lit)

Signal output Alarm

Output description	Relay output
Continuous current	200 mA
Output voltage	24 V
Status display	LED red (malfunction/alarm: LED permanently lit)

Signal output Battery charge

Output description	Relay output
Continuous current	200 mA
Output voltage	24 V
Status display	Yellow LED (Battery charge/battery is being charged: LED flashing)

Signal output Battery mode

Output description	Relay output
Continuous current	200 mA
Output voltage	24 V
Status display	Yellow LED (Battery mode/buffer mode: LED permanently lit)

Standards

Electrical Equipment for Machinery	EN 60204
Safety transformers for power supply units	EN 61558-2-17
Electrical safety (of information technology equipment)	EN 60950/VDE 0805 (SELV) UL/C-UL recognized UL 60950
Industrial control equipment	UL/C-UL Listed UL 508
Electronic equipment for use in electrical power installations SELV	EN 50178/VDE 0160 (PELV) EN 60950 (SELV) EN 60204 (PELV)
Safe isolation	DIN VDE 0100-410 DIN VDE 0106-1010
Protection against electric shock, basic requirements for safe isolation in electrical equipment	DIN VDE 0106-101

General data

Insulation voltage input/output	2 kV (routine test) 4 kV (type test)
Installation position	Horizontal DIN rail NS 35, EN 60715
Degree of protection	IP20
Class of protection	II
MTBF	> 500 000 h in acc. with IEC 61709 (SN 29500)
Housing version	Polyamide PA, color: green
Width	67,5 mm
Height	99 mm
Depth	107 mm
Weight	0.45 kg

Climatic data

Ambient temperature (operation)	-25 °C ... 70 °C (> 60°C derating)
Ambient temperature (storage/transport)	-40 °C ... 85 °C
Max. permissible relative humidity (operation)	95 % (at 25°C, no condensation)
Vibration (operation)	< 15 Hz, amplitude ±2.5 mm in acc. with IEC 60068-2-6 15 Hz ... 150 Hz, 2.3g, 90 min.
Shock	30g in all directions in acc. with IEC 60068-2-27
Pollution degree in acc. with EN 50178	2
Climatic class	3K3 (in acc. with EN 60721)

Conformance with EMC directive 89/336/EEC

Immunity to interference in acc. with EN 61000-6-2

Discharge of static electricity in acc. with EN 61000-4-2

	Housing	Level 3
	Contact discharge	6 kV
	Discharge in air	8 kV
	Comments	Criterion B

Electromagnetic HF field in acc. with EN 61000-4-3

	Housing	Level 3
	Frequency range	80 MHz ... 2 GHz
	Field intensity	10 V/m
	Comments	Criterion A

Fast transients (burst) in acc. with EN 61000-4-4

	Input	4 kV (level 4 - asymmetrical: conductor to ground)
	Output	2 kV (level 3 - asymmetrical: conductor to ground)
	Signal	1 kV (level 2 - asymmetrical: conductor to ground)
	Comments	Criterion B

Surge voltage capacities (surge) in acc. with EN 61000-4-5

	Input	4 kV (level 4 - asymmetrical: conductor to ground)
		2 kV (level 4 - symmetrical: conductor to conductor)
	Output	2 kV (Level 3 - asymmetrical)
		1 kV (Level 3 - symmetrical)
	Signal	2 kV (Level 3 - asymmetrical)
	Comments	Criterion B

Conducted disturbance in acc. with EN 61000-4-6

	Input/Output/Signal	Level 3
	Frequency range	10 kHz ... 80 MHz
	Voltage	10 V
	Comments	Criterion A

Emitted interference in acc. with EN 61000-6-3

Radio interference voltage in acc. with EN 55011	EN 55011 (EN 55022) Class B, area of application: Industry and residential
Emitted radio interference in acc. with EN 55011	EN 55011 (EN 55022) Class B, area of application: Industry and residential

Note:

Criterion A: Normal operating behavior within the defined limits.

Criterion B: Temporary impairment to operational behavior that is corrected by the device itself

EN 55011 corresponds to CISPR11 / EN 55022 corresponds to CISPR22

EN 61000 corresponds to IEC 1000

Block diagram

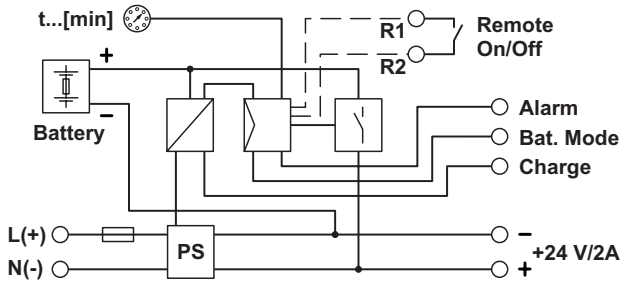

Structure

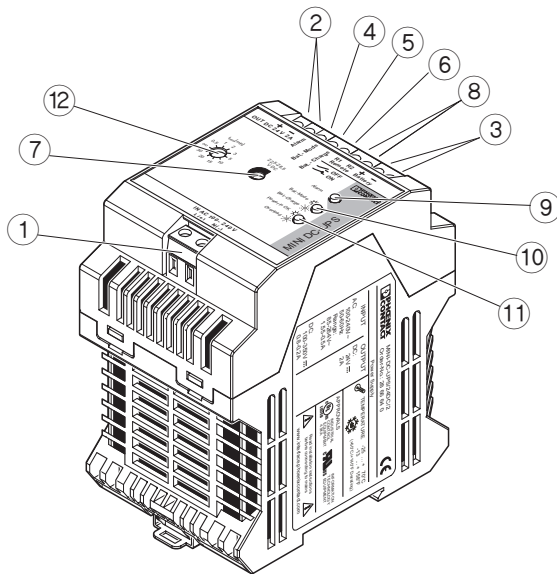

- 1 AC input
- 2 DC output
- 3 Rechargeable battery connection
- 4 Active relay output: Alarm
- 5 Active relay output: Battery mode
- 6 Active relay output: Battery charge
- 7 Potentiometer 22.5 V DC ... 29.5 V DC
- 8 Remote shutdown (R1, R2)
- 9 Red control lamp: Alarm
- 10 Yellow control lamp: Battery mode/ Battery charge
- 11 Green control lamp: Power In OK / Overload
- 12 Buffer time setting 0.5 min ... 30 min and continuous

	[mm ²]		AWG	[Nm] Torque
	solid	stranded		
Input	0.2 - 2.5	0.2 - 2.5	24 - 12	0.5 - 0.6
Output	0.2 - 2.5	0.2 - 2.5	24 - 12	0.5 - 0.6
Signal	0.2 - 2.5	0.2 - 2.5	14 - 24	0.5 - 0.6

Input data

Input nominal voltage range	100 V AC ... 240 V AC
AC input voltage range	85 V AC ... 264 V AC
DC input voltage range	100 V DC ... 350 V DC
Input fuse, integrated	3.15 A (slow-blow, internal)
Type of connection	COMBICON screw/plug connection
Stripping length	8 mm

Output data

Nominal output voltage	24 V DC
Setting range of the output voltage	22.5 V DC ... 29.5 V DC (normal mode; in the buffer mode, dependent on a battery voltage of 27.9 V DC ... 19.2 V DC)
Output current	2 A
Type of connection	COMBICON screw/plug connection
Stripping length	8 mm

Safety and warning notes



The power supply units are built-in devices. The device may only be installed and put into operation by qualified personnel. The corresponding national regulations (e.g. VDE, DIN) must be observed.



Danger!

**Components with dangerously high voltage and high stored energy are located in the device!
Never carry out work on live parts!
Depending on the ambient temperature and the load, the housing can become very hot!**



Before startup please ensure:

The mains connection has been carried out by a competent person and protection against electric shock is guaranteed!

All feed lines are sufficiently protected and dimensioned!

All output lines are dimensioned according to the maximum output current of the device or separately protected!

Sufficient convection is guaranteed!

Installation



In order for the device to function in the manner intended, it is not necessary to observe any minimum spacing to other devices.



The power supply unit can be snapped onto all DIN rails in acc. with EN 60715. They must be horizontal (connecting terminal blocks above and below).

Installation position

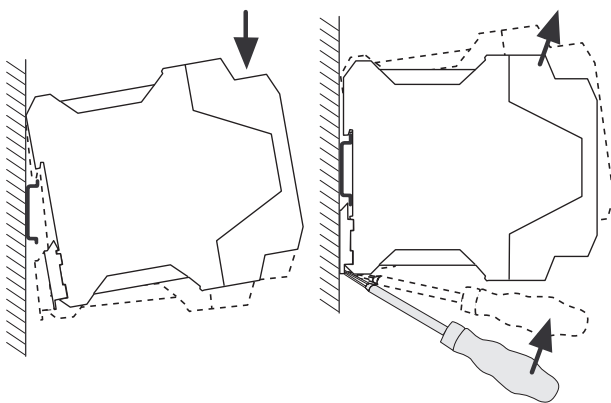

Assembly

Position the module with the DIN rail guide on the upper edge of the DIN rail, and snap it in with a downward motion.

Dismantling

Pull the snap lever open with the aid of a screwdriver and slide the module out at the lower edge of the DIN rail.

Connection, network forms 100...240 V AC networks

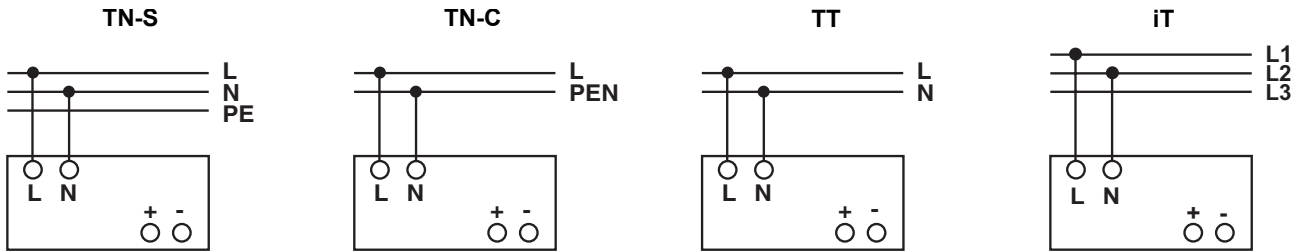

The 100...240 V AC connection is made using the L and N screw connections.
 The device can be connected to 1-phase AC networks or to two of the phase conductors of three-phase systems (TN, TT or IT networks in acc. with VDE 0100-300/IEC 60364-3) with nominal voltages of 100 V AC ...240 V AC.



For operation on two of the phase conductors of a three-phase system, an isolating facility for all poles must be provided.

Input

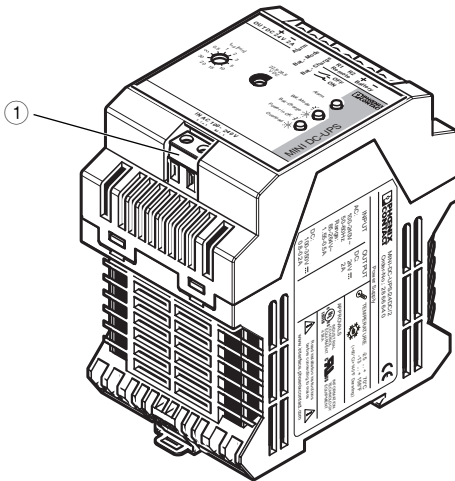

The 100-...240 V AC connection is established using the L and N screw connections.

The device must be installed in acc. with the regulations as in EN 60950. It must be possible to disconnect the device using a suitable isolating facility outside the power supply. The primary side line protection, for example, is suitable. For device protection, there is an internal fuse. Additional device protection is not necessary.



If an internal fuse is triggered, there is most probably a malfunction in the device. In this case, the device must be inspected in the factory!

Output

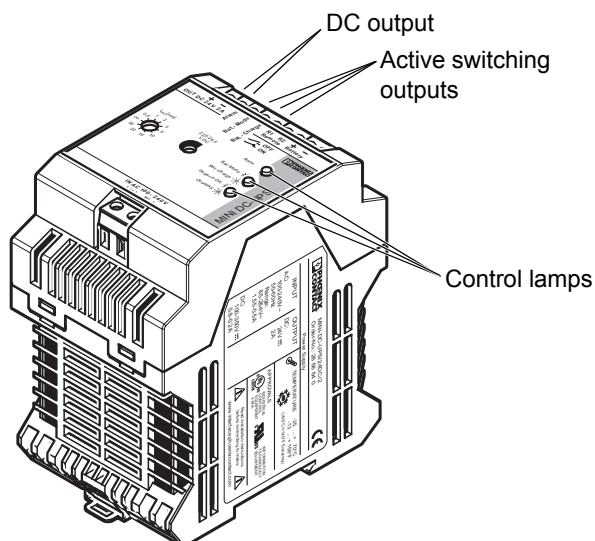

The connection is established through the "OUT DC 24 V, +, -" screw connections. The set output voltage is 24 V DC at the time of delivery. The output voltage from 22.5 V DC to 29.5 V DC can be set on the potentiometer.

Signaling outputs

Signal outputs are connected using "Alarm", "Bat.-Mode" and "Bat.-Charge" terminal blocks. Three control lamps and three active switching outputs are provided for function monitoring.

State	Power In OK	Battery mode/ Battery charge	Alarm
Supply voltage OK, rechargeable battery is being charged	LED on	LED is flashing; Battery mode output: 0 V, Battery charge: 24 V	LED off; output: 0 V
Supply voltage OK, rechargeable battery charged (normal mode)	LED on	LED off; Battery mode / Battery charge output: 0 V	LED off; output: 0 V
Buffer mode	LED off	LED on; Battery mode output: 24 V, Battery charge: 0 V	LED off; output: 0 V
Rechargeable battery discharged, $U_{BAT} < 20.4$ V DC	LED off	LED on; Battery mode / Battery charge output: 0 V	LED on; output: 24 V
Rechargeable battery test negative	LED on	LED off; Battery mode / Battery charge output: 0 V	LED on; output: 24 V
Buffer time over and remote shutdown activated	LED off	LED off; Battery mode / Battery charge output: 0 V	LED off; output: 0 V

Rechargeable battery module

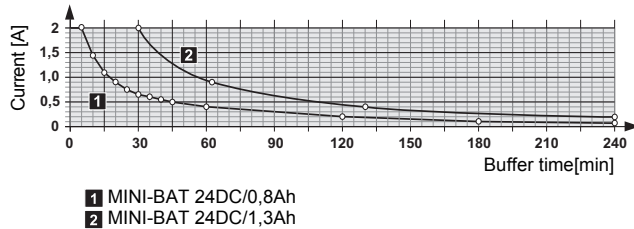

The rechargeable battery module is connected to the power supply unit through the "Battery +" and the "Battery -" terminal blocks. The fuse of the rechargeable battery module must be removed when installing or replacing the module.

The following rechargeable battery modules are recommended:

MINI-BAT 24DC/0.8Ah (order no. 2866666),
MINI-BAT 24DC/1.3Ah (order no. 2866417)

The buffer mode might be terminated after the preset time or due to an external shutdown. If the device is to be switched off after a certain period, the time for it is set using the selector switch at the front of the device. The device can be switched on in the buffer mode again after reconnecting the power supply.

Remote shutdown ("Remote")

The device has a remote shutdown with a UPS function for deliberate shutdown. Remote shutdown must be deactivated for the device to switch over to the buffer mode in the event of a supply voltage failure.

Remote shutdown inactive

- The "Remote shutdown R1" and "Remote shutdown R2" terminal points are short-circuited (e.g. with a plug-in bridge) OR 24 V DC is present at the "Remote shutdown R2" terminal point.
- The power supply unit switches over to the buffer mode in the event of a supply voltage failure.

Remote shutdown active

- The "Remote shutdown R1" and "Remote shutdown R2" terminal points are not short-circuited (e.g. with a plug-in bridge) OR 0 V is present at the "Remote shutdown R2" terminal point.
- All LEDs are off.
- The power supply does not switch over to the buffer mode in the event of a supply voltage failure; the device switches off. The rechargeable battery module is charged when the supply voltage is reconnected, but the device remains switched off until the remote shutdown is activated.
- The connected consumers are fed as long as the supply voltage is available.

Function

Output voltage

In the normal mode, the output voltage of the device conforms to the setting on the potentiometer (22.5 V DC ... 29.5 V DC). If the supply voltage fails, the buffer mode is activated without any interruption and the output voltage is supplied by the rechargeable battery module. The output voltage is now directly dependent on the battery voltage and is $U_{BAT} - 0.5 V$. An alarm signal is triggered if the output voltage drops below 20.4 V in the buffer mode. If the output voltage drops to 19.2 V due to a completely discharged rechargeable battery module, the device switches off and remains switched off. The device switches on automatically only after reconnecting the power supply. The device is electronically protected against short circuit and idling.