

50 ohm nominal input / conjugate match balun for STLC2690, with integrated harmonic filter

Datasheet – production data

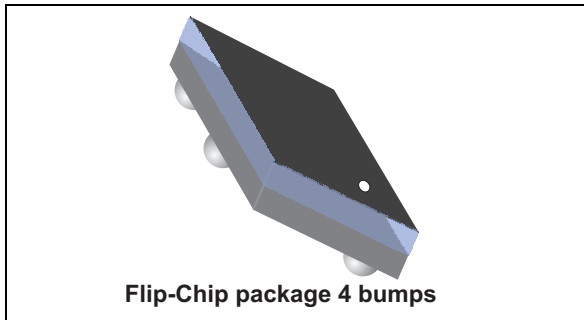

Features

- 50 Ω nominal input / matched output differential impedance
- Integrated harmonic filter
- Low insertion loss
- Low amplitude imbalance
- Low phase imbalance
- Small footprint < 1.54 mm²

Benefits

- Very low profile (< 560 μ m after reflow)
- High RF performance
- RF BOM and area reduction

Applications

- Bluetooth STLC2690 application
- Mobile phone application

Description

STMicroelectronics BALF-2690-02D3 is a balun design to transform single ended signal to differential signals in Bluetooth applications. This BALF-2690-02D3 has been customized for STLC2690 Bluetooth transceiver with less than 1.2 dB insertion losses in the bandwidth (2400 MHz-2500 MHz).

The BALF-2690-02D3 has been designed using STMicroelectronics IPD (integrated passive device) technology on non-conductive glass substrate which optimize RF performance.

Figure 1. Device configuration (top view)

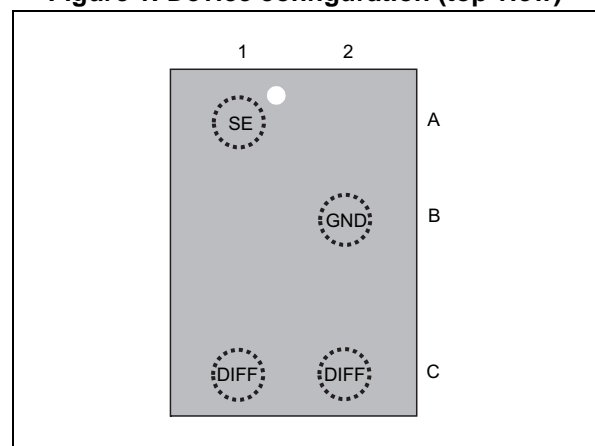
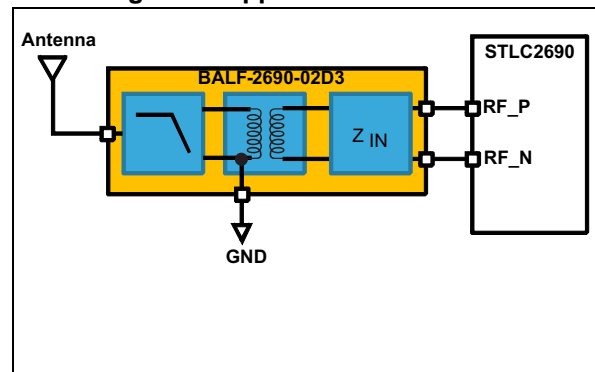

Figure 2. Application schematic



1 Characteristics

Table 1. Absolute maximum ratings (limiting values)

Symbol	Parameter	Value			Unit
		Min.	Typ.	Max.	
P_{IN}	Input power RFIN		10	13	dBm
V_{ESD}	ESD rating, human body model (JESD22-A114-C) all I/O one at a time while others connected to GND	2000			V
	ESD rating, machine model, all I/O	200			
T_{OP}	Operating temperature range	-40		+85	°C

Table 2. Impedances ($T_{amb} = 25\text{ °C}$)

Symbol	Parameter	Value			Unit
		Min.	Typ.	Max.	
Z_{DIFF}	Nominal differential impedance		matched to STLC2690		Ω
Z_{SE}	Nominal single-ended impedance		50		

Table 3. RF performance ($T_{amb} = 25\text{ °C}$)

Symbol	Parameter	Test condition	Value			Unit
			Min.	Typ.	Max.	
f	Frequency range (bandwidth)		2400		2500	MHz
I_L	Insertion loss in bandwidth			+1.2		dB
R_{L_SE}	Return loss in bandwidth		15	21		dB
Φ_{imb}	Output phase imbalance (single ended)		-10		+10	°
A_{imb}	Output amplitude imbalance		-1	0.5	1	dB
CMRR	Common mode rejection (S_{SC12})		20			dB
Att_{2f_0}	2nd harmonic S21 attenuation	4800-5000 MHz	31			dB
Att_{3f_0}	3rd harmonic S21 attenuation	7200-7500 MHz	36			

1.1 Measurements

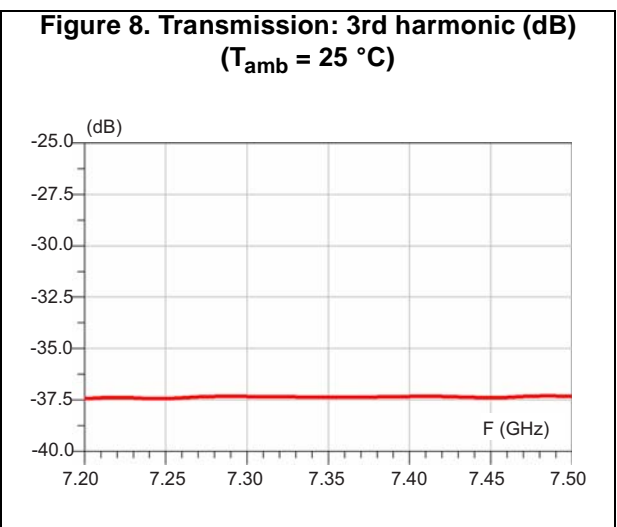
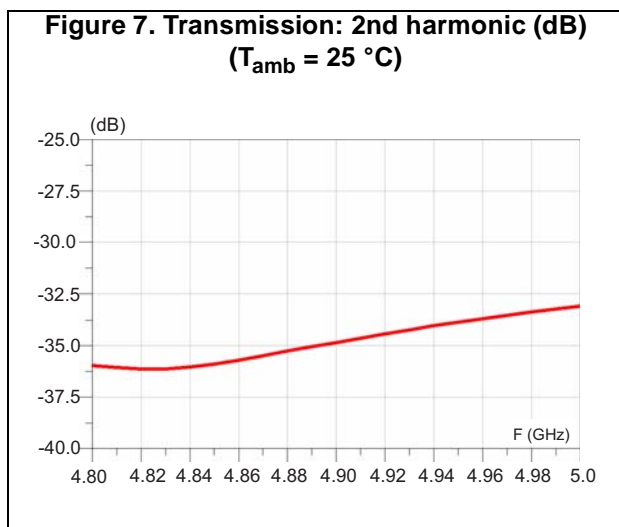
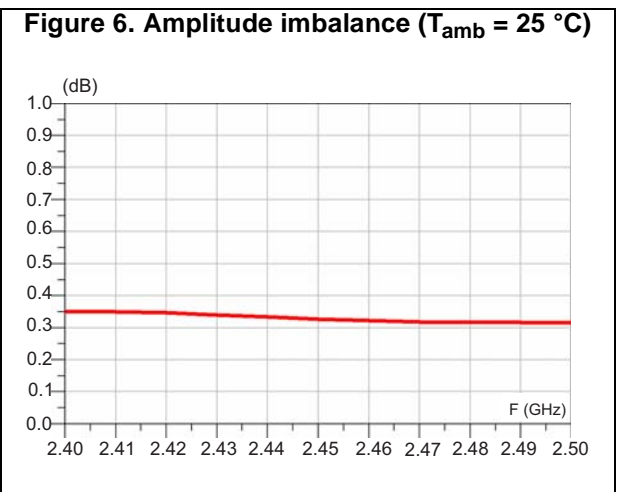
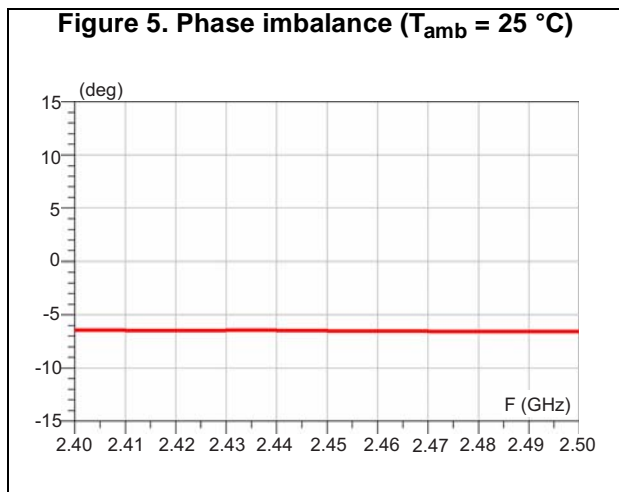
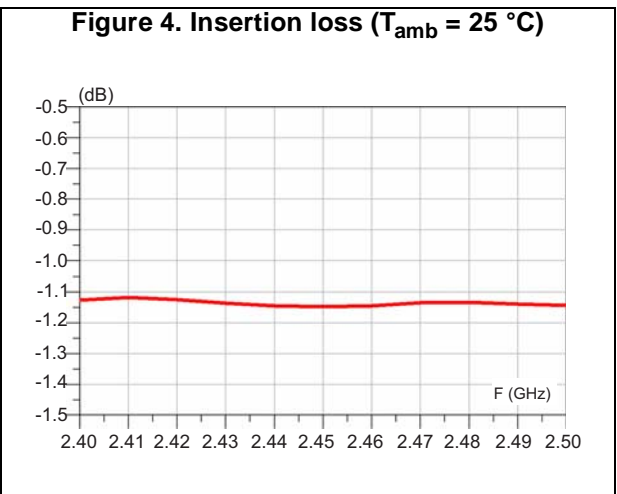
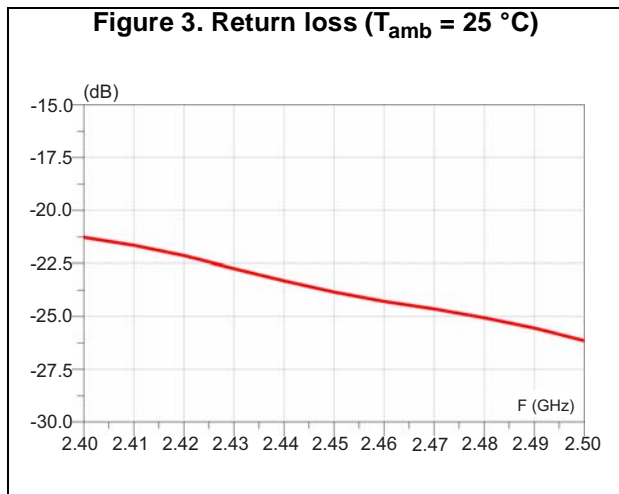

Figure 9. Transmission (dB)



2 Package information

- Epoxy meets UL94, V0
- Lead-free package

In order to meet environmental requirements, ST offers these devices in different grades of ECOPACK® packages, depending on their level of environmental compliance. ECOPACK® specifications, grade definitions and product status are available at: www.st.com. ECOPACK® is an ST trademark.

2.1 Flip-Chip package information

Figure 10. Flip-Chip package outline

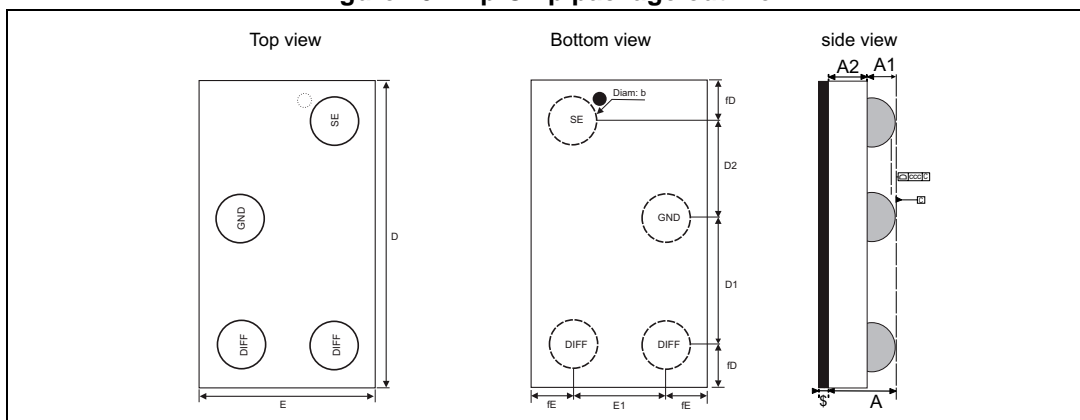

Table 4. Flip-Chip package mechanical data

Parameter	Description	Min.	Typ.	Max.	Unit
A	Bump height + substrate thickness	0.570	0.630	0.690	mm
A1	Bump height	0.155	0.205	0.255	mm
A2	Substrate thickness		0.400		mm
b	Bump diameter	0.215	0.255	0.295	mm
D	Y dimension of the die	1.590	1.640	1.690	mm
D1	Y pitch		0.660		mm
D2	Y pitch2		0.540		mm
E	X dimension of the die	0.890	0.940	0.990	mm
E1	X pitch		0.500		mm
fD	Distance from bump to edge of die on Y axis		0.225		mm
fE	Distance from bump to edge of die on X axis		0.215		mm
ccc				0.05	mm
\$			0.025		mm

Figure 11. Footprint

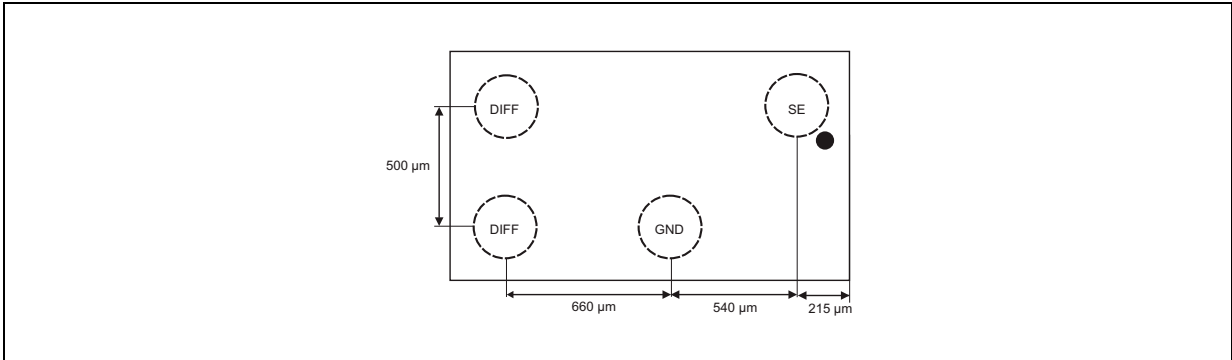

Figure 12. Footprint - 3 mils stencil - non solder mask defined

Copper pad diameter:
220 μm recommended
180 μm minimum
260 μm maximum

Solder mask opening:
320 μm recommended
300 μm minimum
340 μm maximum

Solder stencil opening:
220 μm recommended

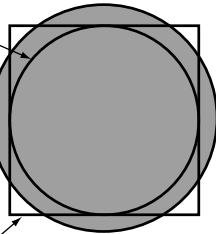

Figure 13. Footprint - 3 mils stencil - solder mask defined

Solder mask opening:
220 μm recommended
180 μm minimum
260 μm maximum

Copper pad diameter:
320 μm recommended
300 μm minimum

Solder stencil opening:
220 μm recommended

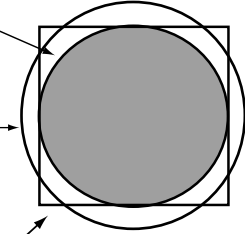

Figure 14. Footprint - 5 mils stencil - non solder mask defined

Copper pad diameter:
220 μm recommended
180 μm minimum
260 μm maximum

Solder mask opening:
320 μm recommended
300 μm minimum
340 μm maximum

Solder stencil opening:
330 μm recommended*

*depending on paste, it can go down to 270 μm

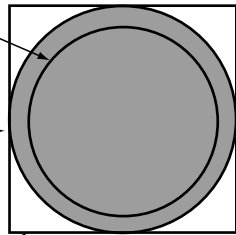

Figure 15. Footprint - 5 mils stencil - solder mask defined

Solder mask opening:
220 μm recommended
180 μm minimum
260 μm maximum

Copper pad diameter:
320 μm recommended
300 μm minimum

Solder stencil opening:
330 μm recommended*

*depending on paste, it can go down to 270 μm

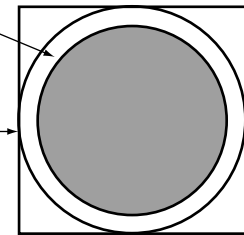

Figure 16. Marking

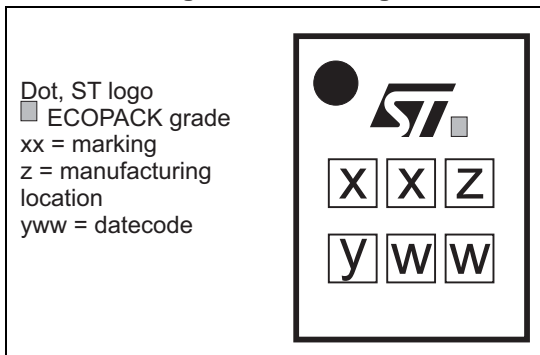

Figure 17. Recommended land pattern

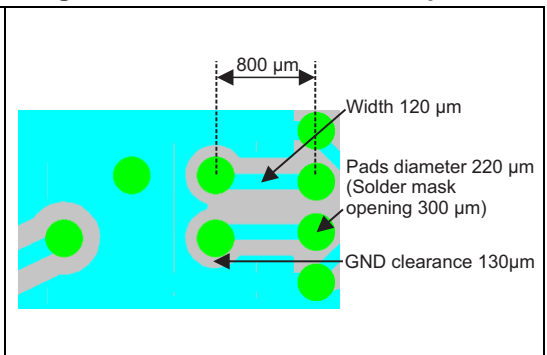
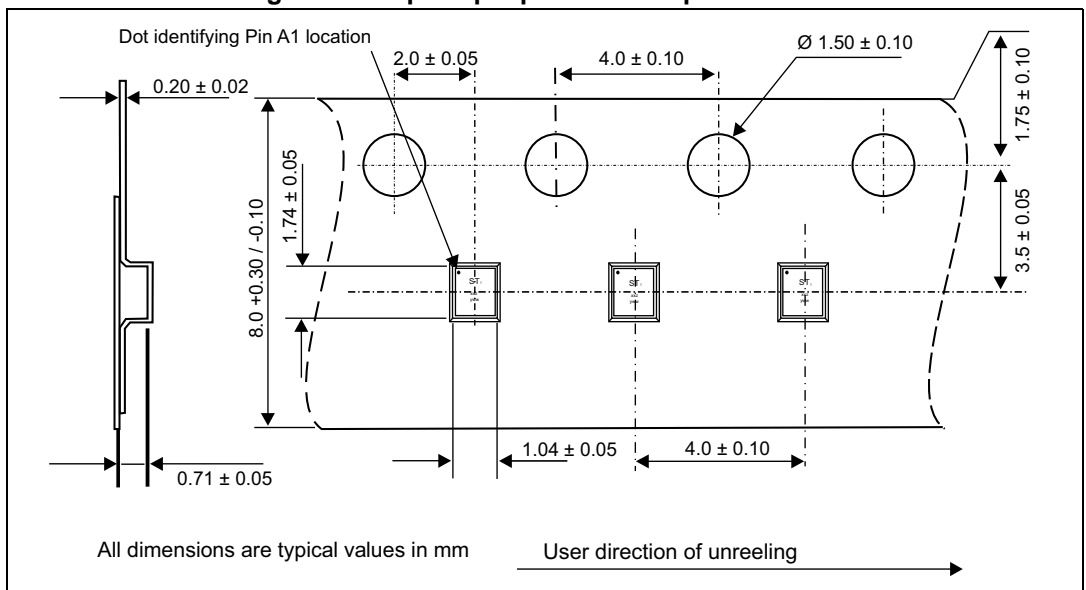

Figure 18. Flip Chip tape and reel specifications



Note: More information is available in the STMicroelectronics application notes: AN2348 Flip-Chip: “Package description and recommendations for use”

3 Ordering information

Table 5. Ordering information

Order code	Marking	Weight	Base Qty	Delivery mode
BALF-2690-02D3	SP	1.81 mg	5000	Tape and Reel

4 Revision history

Table 6. Document revision history

Date	Revision	Changes
27-Sep-2013	1	Initial release
19-Dec-2013	2	Added product weight in Table 5 and updated Table 1 .
19-Nov-2014	3	Added tape and reel dimensions.
02-Sep-2015	4	Updated Figure 10 . Added Figure 12 , Figure 13 , Figure 14 , Figure 15 and Table 4 .

IMPORTANT NOTICE – PLEASE READ CAREFULLY

STMicroelectronics NV and its subsidiaries ("ST") reserve the right to make changes, corrections, enhancements, modifications, and improvements to ST products and/or to this document at any time without notice. Purchasers should obtain the latest relevant information on ST products before placing orders. ST products are sold pursuant to ST's terms and conditions of sale in place at the time of order acknowledgement.

Purchasers are solely responsible for the choice, selection, and use of ST products and ST assumes no liability for application assistance or the design of Purchasers' products.

No license, express or implied, to any intellectual property right is granted by ST herein.

Resale of ST products with provisions different from the information set forth herein shall void any warranty granted by ST for such product.

ST and the ST logo are trademarks of ST. All other product or service names are the property of their respective owners.

Information in this document supersedes and replaces information previously supplied in any prior versions of this document.

© 2015 STMicroelectronics – All rights reserved