

Data sheet / Datenblatt 523220000

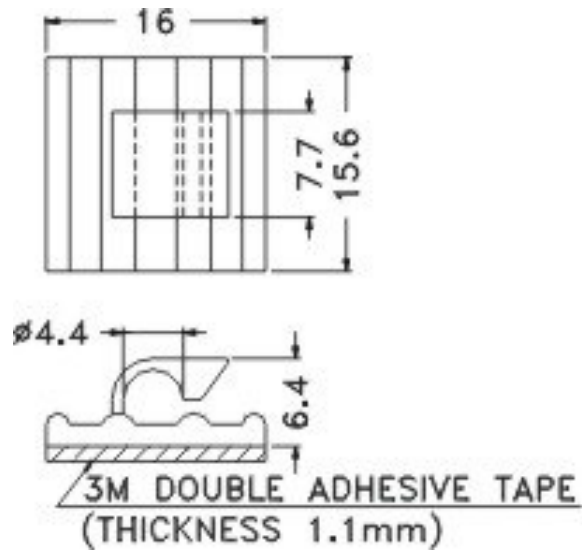

Artikelnr. / Article no. 523220000	Material: Nylon 66 UL94 V-2
Klebesockel / Two way base with adhesive	Natur / natural
	Geprüft / Drawn Mark Wirth 2007-10-18

Würth Elektronik eiSos GmbH & Co KG
 D – 74638 Waldenburg
 Max-Eyth-Straße 1
 Tel.: 0049 7942-945-0 / Fax: 0049 7942-945-400
www.we-online.de