

Spezifikation für Freigabe / specification for release

Kunde / customer :

Artikelnummer / part number : **744870680**

Bezeichnung : **DOPPELDROSSEL WE-DD**

description : **POWER-CHOKE WE-DD**

LF



DATUM / DATE : 2005-03-29

A Mechanische Abmessungen / dimensions:

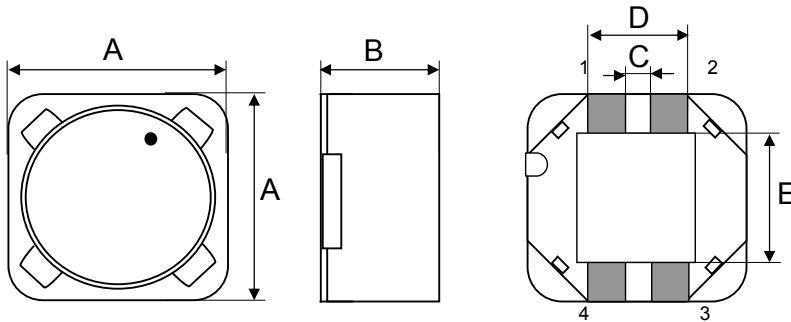

	Typ XL	
A	12,5 max.	mm
B	8,5 max.	mm
C	1,5 ± 0,2	mm
D	4,9 ± 0,2	mm
E	7,3 ± 0,5	mm

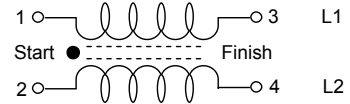

B Elektrische Eigenschaften / electrical properties:

Eigenschaften / properties	Testbedingungen / test conditions		Wert / value	Einheit / unit	tol.
Induktivität (je Wicklg.) / inductance (each wdg.)	1 kHz / 0,25V	L ₁ , L ₂	68,0	μH	±20%
DC-Widerstand (je Wicklg.) / DC-resistance (each wdg)		R _{DC1,2 typ}	0,170	Ω	typ.
DC-Widerstand (je Wicklg.) / DC-resistance (each wdg)		R _{DC1,2 max}	0,215	Ω	max.
Nennstrom (je Wicklg.) / rated Current (each wdg.)	ΔT = 40 K	I _{N1} , I _{N2}	1,35	A	max.
Sättigungsstrom (je Wicklg.) / saturation current (each wdg.)	ΔL/Lo = -10%	I _{sat}	3,00	A	typ.
Eigenres.-Frequenz / self-res.-frequency		SRF	3,7	MHz	typ.
Nennspannung / rated voltage		U _{DC}	80,0	V	max.

C Lötpad / soldering spec.:

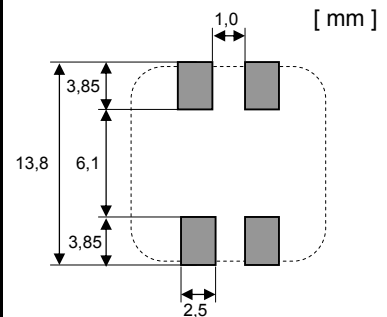

D Prüfgeräte / test equipment:

HP 4274 A für/for L und/and Q
HP 34401 A für/for I_{bc} und/and R_{bc}

E Testbedingungen / test conditions:

Luftfeuchtigkeit / humidity: 33%
Umgebungstemperatur / temperature: +20°C

F Werkstoffe & Zulassungen / material & approvals:

Basismaterial / base material: Ferrit/ ferrite
Draht / wire: 2 SFBW; 155°C

G Eigenschaften / general specifications:

Betriebstemp. / operating temperature: -40°C - + 125°C
Umgebungstemp. / ambient temperature: -40°C - + 85°C
It is recommended that the temperature of the part does not exceed 125°C under worst case operating conditions.

Freigabe erteilt / general release:	Kunde / customer		
.....	Unterschrift / signature		
Datum / date	Würth Elektronik		
.....	SST	Version 6	05-03-29
.....	SST	Version 4	04-09-15
.....	SST	Version 1	04-03-09
Geprüft / checked	Name	Änderung / modification	Datum / date

Würth Elektronik eiSos GmbH & Co. KG

D-74638 Waldenburg · Max-Eyth-Strasse 1 · Germany · Telefon (+49) (0) 7942 - 945 - 0 · Telefax (+49) (0) 7942 - 945 - 400
http://www.we-online.de

Spezifikation für Freigabe / specification for release

Kunde / customer : _____
 Artikelnummer / part number : **744870680**
 Bezeichnung : **DOPPELDROSSEL WE-DD**
 description : **POWER-CHOKE WE-DD**

LF



DATUM / DATE : 2005-03-29

H Induktivitätskurve / Inductance curve:

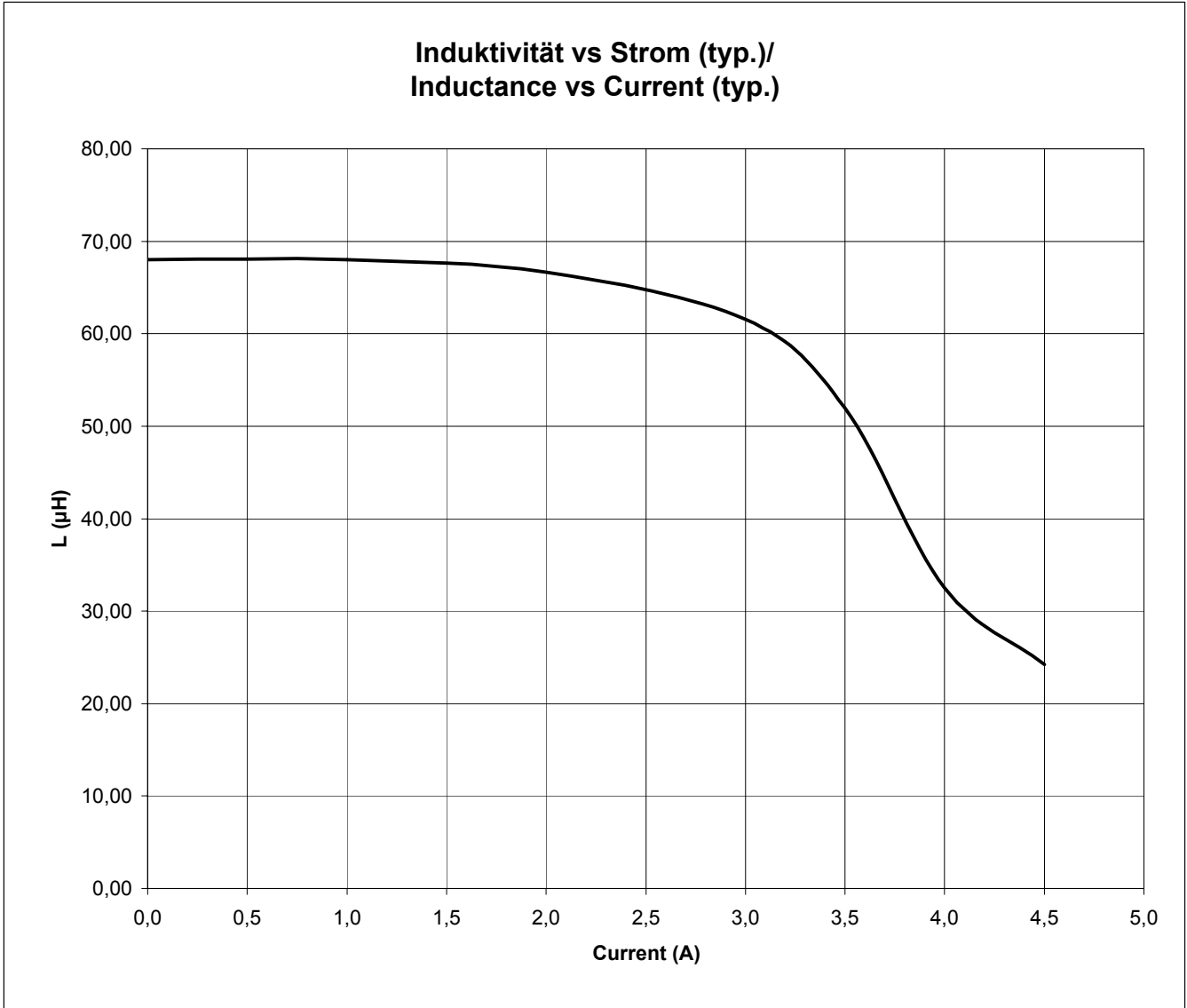

Freigabe erteilt / general release:	Kunde / customer			
Datum / date	Unterschrift / signature			
	Würth Elektronik	SST	Version 6	05-03-29
		SST	Version 4	04-09-15
		SST	Version 1	04-03-09
Geprüft / checked	Kontrolliert / approved	Name	Änderung / modification	Datum / date

Würth Elektronik eiSos GmbH & Co. KG

D-74638 Waldenburg · Max-Eyth-Strasse 1 · Germany · Telefon (+49) (0) 7942 - 945 - 0 · Telefax (+49) (0) 7942 - 945 - 400
<http://www.we-online.de>

Spezifikation für Freigabe / specification for release

Kunde / customer :

Artikelnummer / part number : **744870680**

LF



Bezeichnung : **DOPPELDROSSEL WE-DD**

description : **POWER-CHOKE WE-DD**

DATUM / DATE : 2005-03-29

I Rollenspezifikation / tape and reel specification:

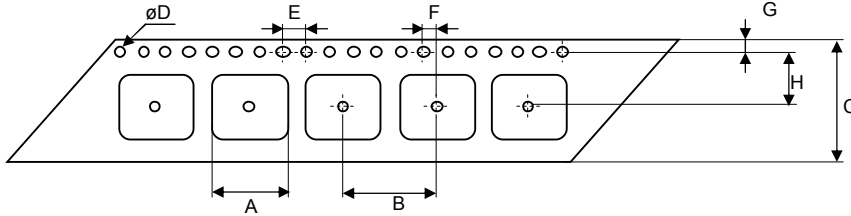

Gurtspezifikation / Tape specification:		
A	12,5 ± 0,1	mm
B	16,0 ± 0,1	mm
C	24,0 ± 0,3	mm
D	1,50 ^{+0,1} - 0,0	mm
E	4,00 ± 0,1	mm
F	2,00 ± 0,1	mm
G	1,75 ± 0,1	mm
H	11,5 ± 0,1	mm
I	12,6 ± 0,1	mm
J	8,50 ± 0,1	mm
T	0,40 ± 0,05	mm

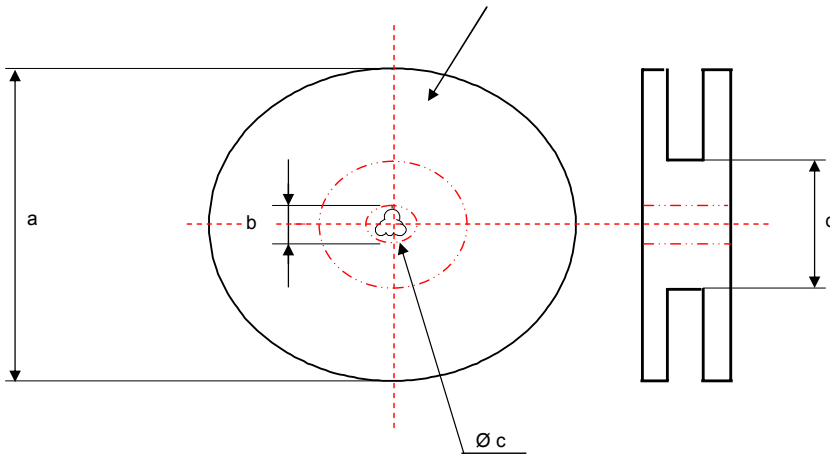
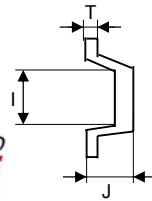

Rollenspezifikation / Reel specification:		
a	330,0 ± 2,0	mm
b	21,00 ± 0,8	mm
c	13,00 ± 0,5	mm
d	100,0 ± 1,0	mm

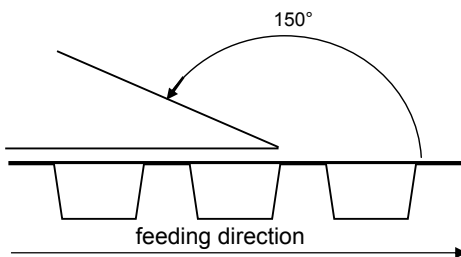

The force for tearing off cover tape is 20 to 70 grams in arrow direction

Freigabe erteilt / general release:	Kunde / customer		
Datum / date	Unterschrift / signature		
	Würth Elektronik		
Geprüft / checked	SST	Version 6	05-03-29
	SST	Version 4	04-09-15
	SST	Version 1	04-03-09
	Name	Änderung / modification	Datum / date

This electronic component is designed and developed with the intention for use in general electronics equipments. Before incorporating the components into any equipments in the field such as aerospace, aviation, nuclear control, submarine, transportation, (automotive control, train control, ship control), transportation signal, disaster prevention, medical, public information network etc. where higher safety and reliability are especially required or if there is possibility of direct damage or injury to human body. In addition, even electronic component in general electronic equipments, when used in electrical circuits that require high safety, reliability functions or performance, the sufficient reliability evaluation-check for the safety must be performed before use. It is essential to give consideration when to install a protective circuit at the design stage.

Würth Elektronik eiSos GmbH & Co. KG

D-74638 Waldenburg · Max-Eyth-Strasse 1 · Germany · Telefon (+49) (0) 7942 - 945 - 0 · Telefax (+49) (0) 7942 - 945 - 400
http://www.we-online.de